

Description

- 1-10 m sensing range
- 34 to 274 cross scanning beams
- Active height of 650 mm to 2535 mm
- Detector length of 850 mm to 2800 mm
- Cable or plug connection
- Automatic sensitivity adjustment
- Water-resistant, slim line (12x30 mm) detector housing
- Power, output and signal status indicators
- 12-36 V dc supply voltage
- 5 wire, solid state relay output
- Test input
- Light/dark function via wire connection



The SG 10 light curtain system consists of a self-contained transmitter detector, SGT and receiver detector, SGR, which are to be positioned opposite of each other. The detectors are housed in a water-resistant, aluminium profile available in a slim line design (12 x 30 mm).

The SGR is supplied with a 12-36 V dc power supply with a 5 wire, solid state relay output, with wire selectable light or dark function. The test input in the SGT may be used for either disabling or enabling the transmitting power temporarily for test purposes.

The advanced automatic signal-tracking (AST) feature ensures that no onsite set up or adjustments are required. The signal level of each

individual channel is adjusted automatically, which compensates for misalignment and contamination during operation. Transmitter and receiver detectors are optically synchronised.

Specialised signal processing technology, designed for outdoor environments, reduces the risk of false detections of water, rain or snow that may pass between the detectors during operation.

Both the transmitter and receiver detectors are protected against reverse polarity of power supplies, control input and output signals. The output is also protected against short circuit and inductive loads.

Technical Data					
		46 mm channel spacing		92 mm channel spacing	
		SGT	SGR	SGT	SGR
Supply voltage		12-36 V dc			
Current consumption		Max. 100 mA	50 mA	Max. 100 mA	50 mA
Output rating		Solid state		Solid state	
		-	200 mA	-	200 mA
Short circuit protected		-	Yes	-	Yes
Reverse polarity protected		Yes			
Light source		Infrared (880 nm)	-	Infrared (880 nm)	-
Number of channels (diodes per detector)		16, 24, 32, 40, 48 or 56		8, 12, 16, 20, 24 or 28	
Number of cross scanning beams		74, 114, 154, 194, 234 or 274		34, 54, 74, 94, 114 or 134	
Active height		695, 1065, 1430, 1800, 2165 or 2535 mm		650, 1020, 1385, 1755, 2120 or 2490 mm	
Channel spacing		46 mm		92 mm	
Bottom spacing to Ch 1		25 mm			
Pinch point beam spacing		23 mm		46 mm	
Response time		-	< 165 ms	-	< 85 ms
Power on indicator		Green LED			
Output indicator		-	Yellow LED	-	Yellow LED
System status indicator		-	Red LED	-	Red LED
Time-out function		-			
Housing dimensions (w x d)		Slim Line C		12 x 30 mm	
Housing material		Profile		Aluminium (black anodised)	
		Lens cover		Polycarbonate	
Connection		5 m fixed cable or 0,5 m cable with 5 pin, M12 plug			
Cable, PVC Ø 4,9 mm		3 x 0,20 mm ²	5 x 0,20 mm ²	3 x 0,20 mm ²	5 x 0,20 mm ²

Environmental Data

		SGT	SGR
Light immunity @ 5° incidence		-	> 100 000 lux
Temperature, operation		-20 to +65 °C	
Temperature, storage		-40 to +80 °C	
Sealing class	C housing	IP 67	
Approvals		CE	

Available Types

Slim Line C

	Housing Length	Active Height	Number of Channels	Number of Beams	Beam Spacing	Connection		5 m cable	0.5 m cable with 5 pin, M12 plug	Range				
						Output	Order Reference							
Transmitter Detector	850 mm	650 mm	8	34	92 mm	-	-	SGT 10-085-008-B1-C-01-5	SGT 10-085-008-B1-C-01-0.5-J5	10 m				
		695 mm	16	74	46 mm			SGT 10-085-016-A1-C-01-5	SGT 10-085-016-A1-C-01-0.5-J5					
	1250 mm	1020 mm	12	54	92 mm			SGT 10-125-012-B1-C-01-5	SGT 10-125-012-B1-C-01-0.5-J5					
		1065 mm	24	114	46 mm			SGT 10-125-024-A1-C-01-5	SGT 10-125-024-A1-C-01-0.5-J5					
	1600 mm	1385 mm	16	74	92 mm			SGT 10-160-016-B1-C-01-5	SGT 10-160-016-B1-C-01-0.5-J5					
		1430 mm	32	154	46 mm			SGT 10-160-032-A1-C-01-5	SGT 10-160-032-A1-C-01-0.5-J5					
	2000 mm	1755 mm	20	94	92 mm			SGT 10-200-020-B1-C-01-5	SGT 10-200-020-B1-C-01-0.5-J5					
		1800 mm	40	194	46 mm			SGT 10-200-040-A1-C-01-5	SGT 10-200-040-A1-C-01-0.5-J5					
	2400 mm	2120 mm	24	114	92 mm			SGT 10-240-024-B1-C-01-5	SGT 10-240-024-B1-C-01-0.5-J5					
		2165 mm	48	234	46 mm			SGT 10-240-048-A1-C-01-5	SGT 10-240-048-A1-C-01-0.5-J5					
	2800 mm	2490 mm	28	134	92 mm			SGT 10-280-028-B1-C-01-5	SGT 10-280-028-B1-C-01-0.5-J5					
		2535 mm	56	274	46 mm			SGT 10-280-056-A1-C-01-5	SGT 10-280-056-A1-C-01-0.5-J5					
	Receiver Detector	850 mm	650 mm	8	34			92 mm	Solid State Relay		DO/LO (NO/NC)	SGR 10-085-008-B1-C-07-5	SGR 10-085-008-B1-C-07-0.5-J5	1-10 m
			695 mm	16	74			46 mm				SGR 10-085-016-A1-C-07-5	SGR 10-085-016-A1-C-07-0.5-J5	
1250 mm		1020 mm	12	54	92 mm	SGR 10-125-012-B1-C-07-5	SGR 10-125-012-B1-C-07-0.5-J5							
		1065 mm	24	114	46 mm	SGR 10-125-024-A1-C-07-5	SGR 10-125-024-A1-C-07-0.5-J5							
1600 mm		1385 mm	16	74	92 mm	SGR 10-160-016-B1-C-07-5	SGR 10-160-016-B1-C-07-0.5-J5							
		1430 mm	32	154	46 mm	SGR 10-160-032-A1-C-07-5	SGR 10-160-032-A1-C-07-0.5-J5							
2000 mm		1755 mm	20	94	92 mm	SGR 10-200-020-B1-C-07-5	SGR 10-200-020-B1-C-07-0.5-J5							
		1800 mm	40	194	46 mm	SGR 10-200-040-A1-C-07-5	SGR 10-200-040-A1-C-07-0.5-J5							
2400 mm		2120 mm	24	114	92 mm	SGR 10-240-024-B1-C-07-5	SGR 10-240-024-B1-C-07-0.5-J5							
		2165 mm	48	234	46 mm	SGR 10-240-048-A1-C-07-5	SGR 10-240-048-A1-C-07-0.5-J5							
2800 mm		2490 mm	28	134	92 mm	SGR 10-280-028-B1-C-07-5	SGR 10-280-028-B1-C-07-0.5-J5							
		2535 mm	56	274	46 mm	SGR 10-280-056-A1-C-07-5	SGR 10-280-056-A1-C-07-0.5-J5							

Note: The transmitter SGT and receiver SGR set must have the same number of channels and beam spacing.

Connections

	Cable	M12 Plug / Cable
Supply +	Brown	Pin 1 / Brown
Supply -	Blue	Pin 3 / Blue
SGT test input	Black	Pin 4 / Black
SGR output	Black	Pin 4 / Black
SGR output	Black	Pin 5 / Grey
SGR DO/LO control	White	Pin 2 / White

5 pin, M12

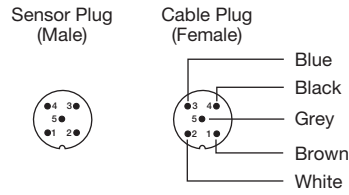

Refer to page 161 for extension cables

Wiring Diagrams

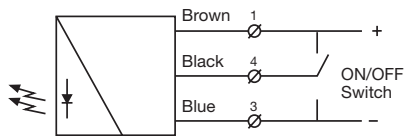

SGT 10
Connect black test input wire to + or - to disable SGT

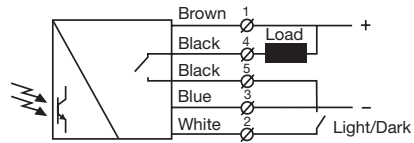

SGR 10 (load as NPN)

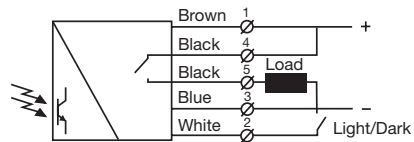

SGR 10 (load as PNP)

Dimensions and Descriptions

Slim Line C

Details

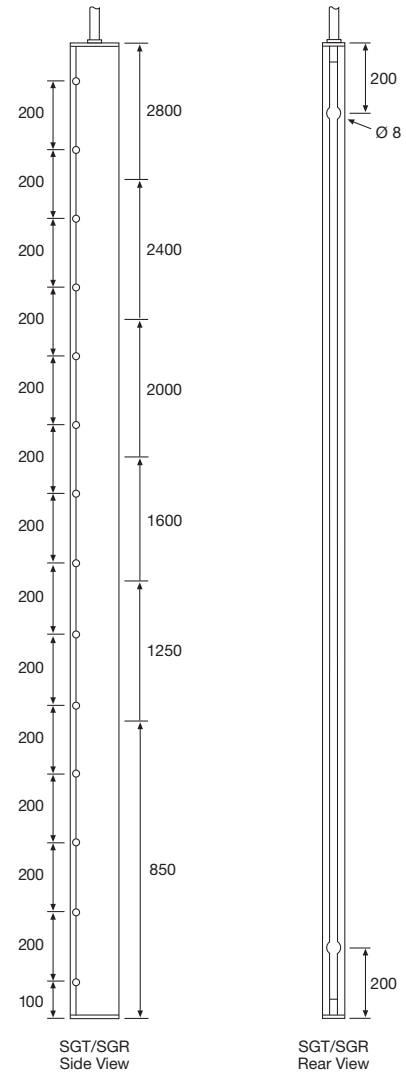
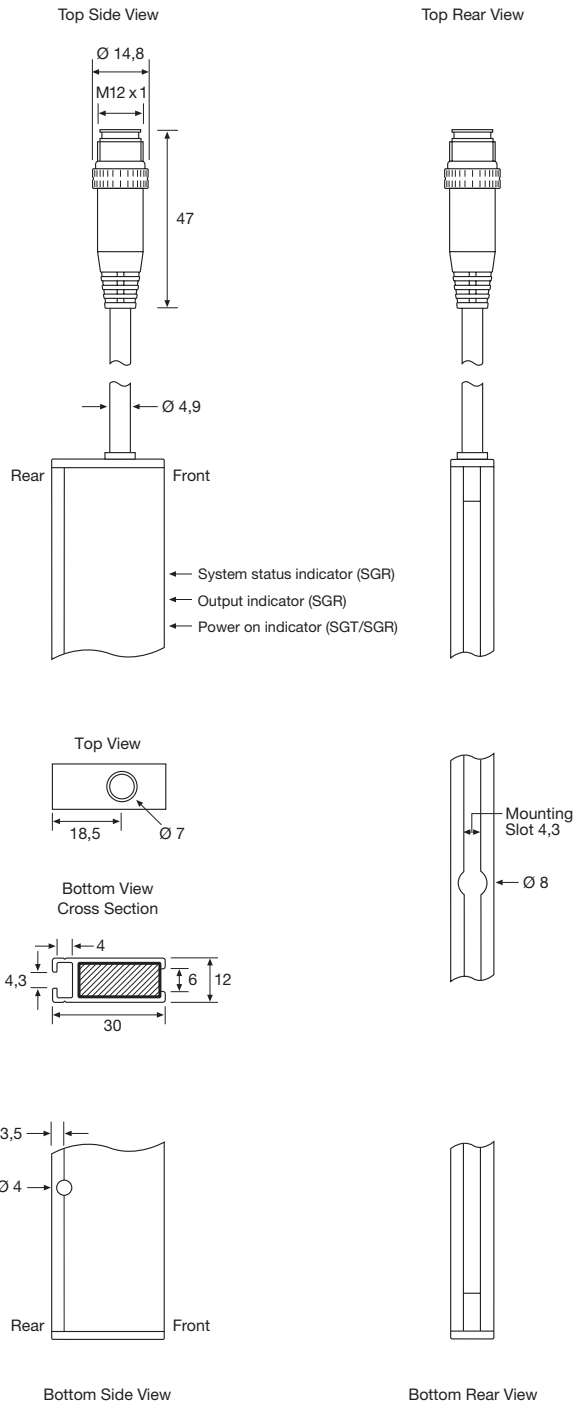

Note: Drawing shows model with M12 plug

(Units in mm)

Beam Patterns

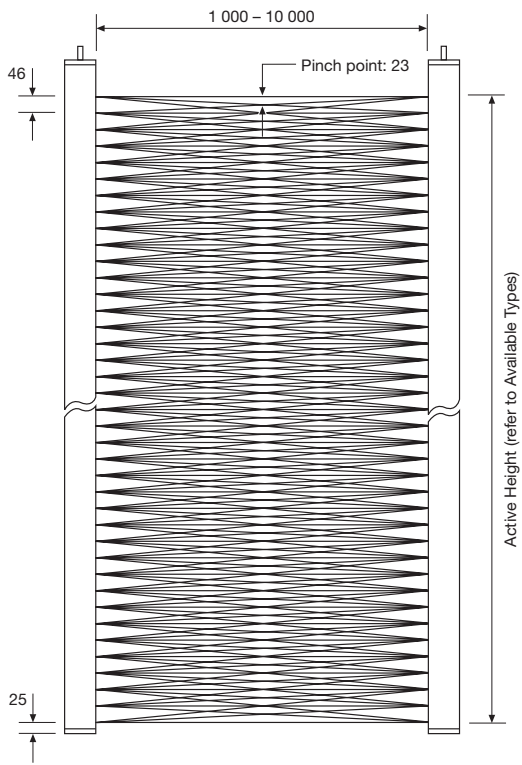

46 mm channel spacing

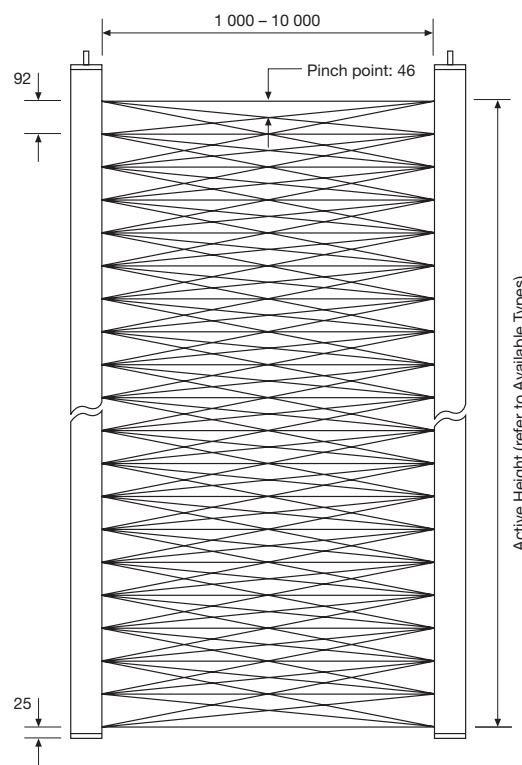

92 mm channel spacing

(Units in mm)

Sensing Characteristics

Parallel Displacement

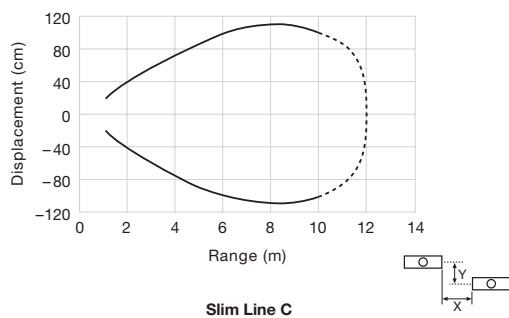

Telco reserves the right to change specifications without notice.